

NOTES:

1. ALL DIMENSIONS FOR REFERENCE ONLY
2. REFER TO AIR LOGIC'S #10-32 INTERFACE & SEAL GUIDE
3. REFER TO AIR LOGIC'S POLYSULFONE APPLICATIONS GUIDE

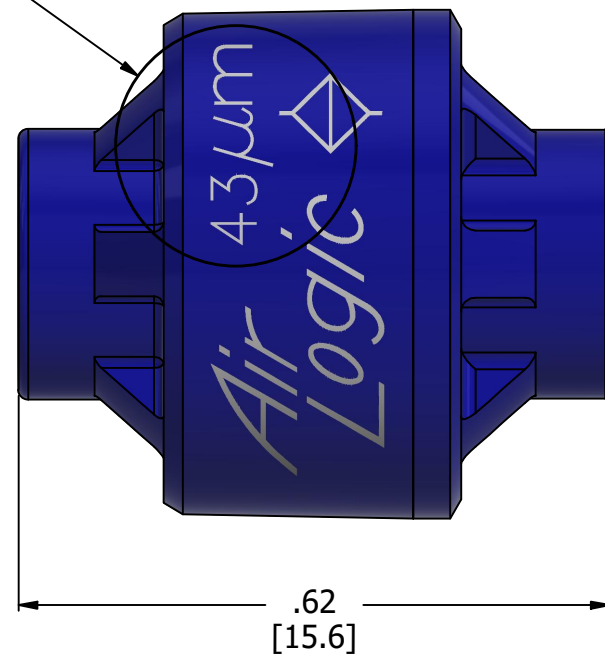

FILTER SIZE CALLOUT



Ø.53  
[Ø13.5]

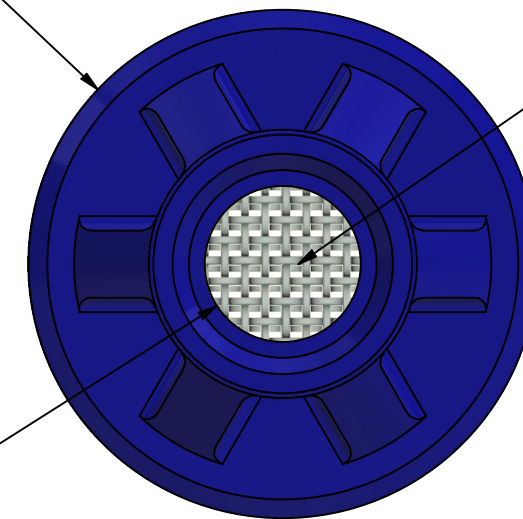

FILTER AREA,  
.164 in<sup>2</sup>  
105 mm<sup>2</sup>

M5x0.8 - 6H  $\nabla$  .17, NOTE 2  
[M5x0.8 - 6H  $\nabla$  4.4, NOTE 2]

PRODUCT SPECIFICATIONS	
COLOR(S)	DARK BLUE, WHITE
FILTER AREA	.164 in <sup>2</sup> , [105 mm <sup>2</sup> ]
FILTER SIZE	43 MICRON
MEDIA	GASES, LIQUIDS, NOTE 3
MAX INLET PRESSURE	125 PSI, [8.6 BAR]
WETTED MATERIALS	POLYSULFONE, STAINLESS STEEL



**AIR-LOGIC** @ DIVISION OF KNAPP MFG, INC.  
5102 DOUGLAS AVE RACINE, WI 53402  
PHONE: (262) 639-9035 FAX: (262) 639-5996 WEB: AIR-LOGIC.COM

PART/DRAWING NO.:

**F970M543**

DESCRIPTION:  
THREADED INLINE FILTER, 43 MICRON, M5

REVISION: A

DRAWN: 2/26/2021

SCALE: 5 : 1

SHEET SIZE: B

TERMS OF USE:

THIS DRAWING IS FOR INFORMATIONAL PURPOSES ONLY. AIR LOGIC MAKES NO REPRESENTATIONS OF WARRANTIES CONCERNING SUITABILITY FOR ANY PARTICULAR PURPOSE. ALL PRODUCTS SUPPLIED ARE SUBJECT TO TERMS AND CONDITIONS FOUND AT AIR-LOGIC.COM

DRAWING TAKES PRECEDENCE OVER 3D MODEL GEOMETRY

TOLERANCE: DECIMALS .00 ± .01, .000 ± .005, FRACTIONS ± 1/64  
ANGLES 1/4° UNLESS OTHERWISE SPECIFIED  
UNITS: INCHES [MILLIMETERS]