

- NOTES:  
 1. ALL DIMENSIONS FOR REFERENCE ONLY  
 2. REFER TO AIR LOGIC'S POLYSULFONE APPLICATION GUIDE  
 3. TUBE RETENTION PRESSURE SUBJECT TO TUBING DIMENSION AND STIFFNESS

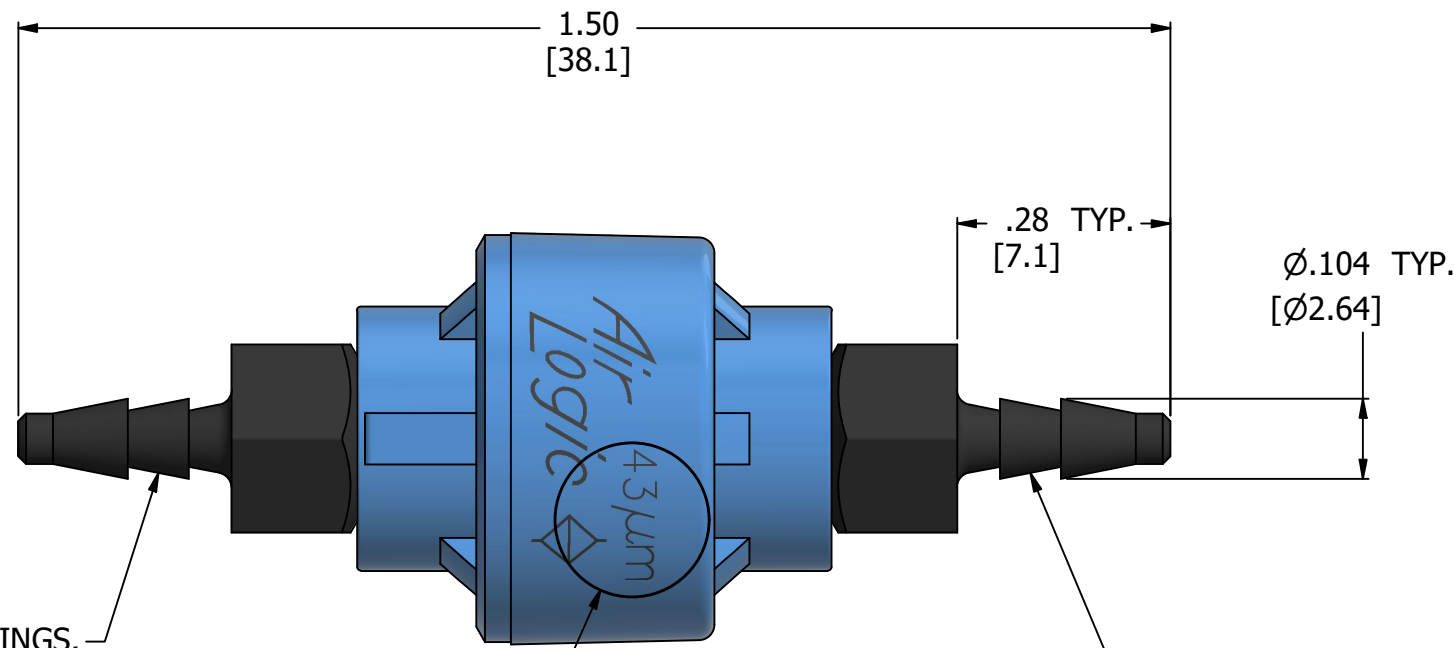

PREINSTALLED FITTINGS,  
SEE COMPONENT F312080  
FOR DETAILS

FILTER SIZE CALLOUT

BARBED CONNECTIONS FOR 1/16" [1.6] I.D. TUBE,  
FIRST BARB FREE OF PARTING LINE

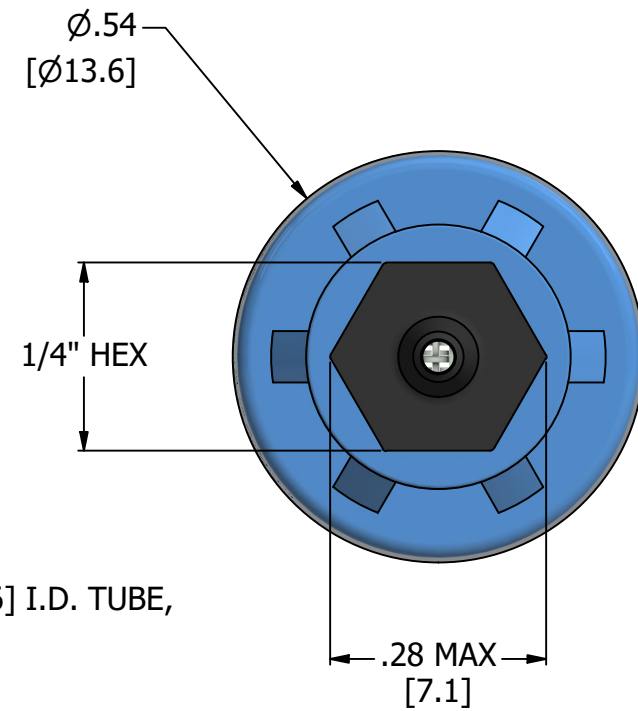
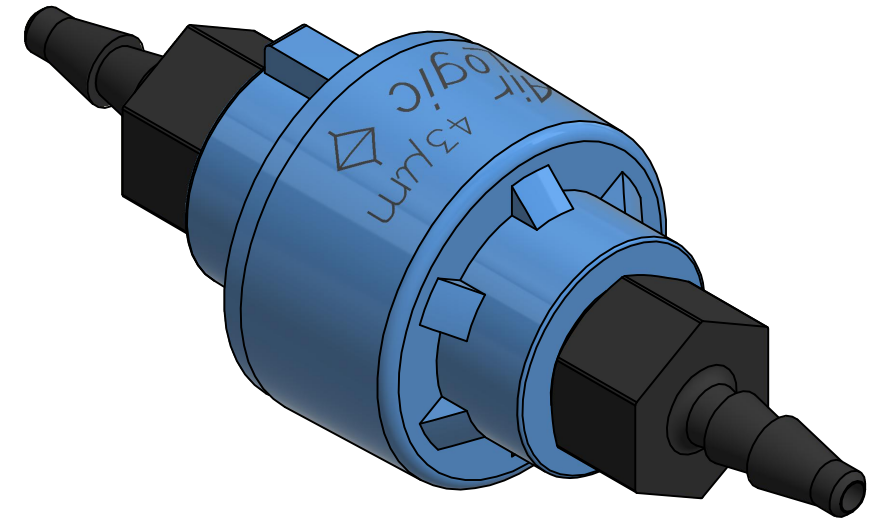

PRODUCT SPECIFICATIONS	
COLOR(S)	LIGHT BLUE, BLACK PRINT
FILTER AREA	.164 in <sup>2</sup> , [105 mm <sup>2</sup> ]
FILTER SIZE	43 MICRON
MEDIA	GASES, LIQUIDS, NOTE 2
MAX INLET PRESSURE	125 PSI, [8.6 BAR]
TYPICAL TUBE RETENTION PRESSURE	125 PSI, [8.6 BAR], NOTE 3
MINIMUM INNER DIAMETER DIAMETER	Ø.045 [Ø1.14]
WETTED MATERIALS	POLYSULFONE, STAINLESS STEEL, NYLON

 **AIR-LOGIC** @ DIVISION OF KNAPP MFG, INC.  
 5102 DOUGLAS AVE RACINE, WI 53402  
 PHONE: (262) 639-9035 FAX: (262) 639-5996 WEB: AIR-LOGIC.COM

PART/DRAWING NO.:  
**F97043B80**

DESCRIPTION:  
 THREADED INLINE FILTER, 43 MICRON, 1/16" BARBS

REVISION: A	DRAWN: 2/25/2021
SCALE: 4 : 1	SHEET SIZE: B

TERMS OF USE:  
 THIS DRAWING IS FOR INFORMATIONAL PURPOSES ONLY. AIR LOGIC MAKES NO REPRESENTATIONS OF WARRANTIES CONCERNING SUITABILITY FOR ANY PARTICULAR PURPOSE. ALL PRODUCTS SUPPLIED ARE SUBJECT TO TERMS AND CONDITIONS FOUND AT AIR-LOGIC.COM

DRAWING TAKES PRECEDENCE OVER 3D MODEL GEOMETRY  
 TOLERANCE: DECIMALS .00 ± .01, .000 ± .005, FRACTIONS ± 1/64  
 ANGLES 1/4° UNLESS OTHERWISE SPECIFIED  
 UNITS: INCHES [MILLIMETERS]