

- NOTES:
 1. ALL DIMENSIONS FOR REFERENCE ONLY
 2. REFER TO AIR-LOGIC'S #10-32 INTERFACE & SEAL GUIDE
 3. TUBE RETENTION PRESSURE SUBJECT TO TUBING DIMENSION AND STIFFNESS

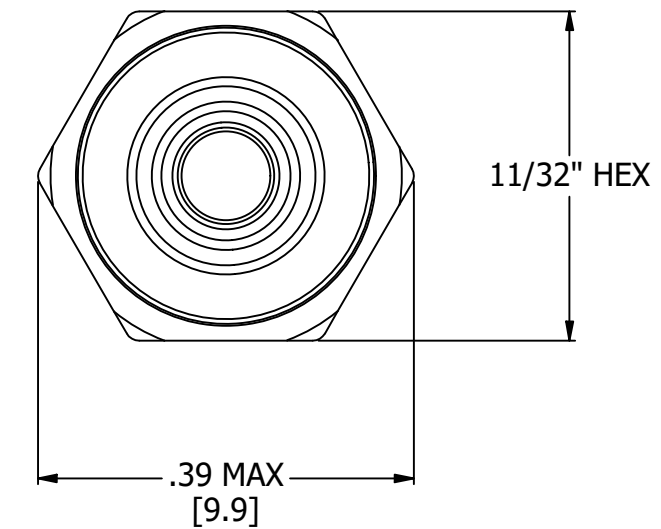
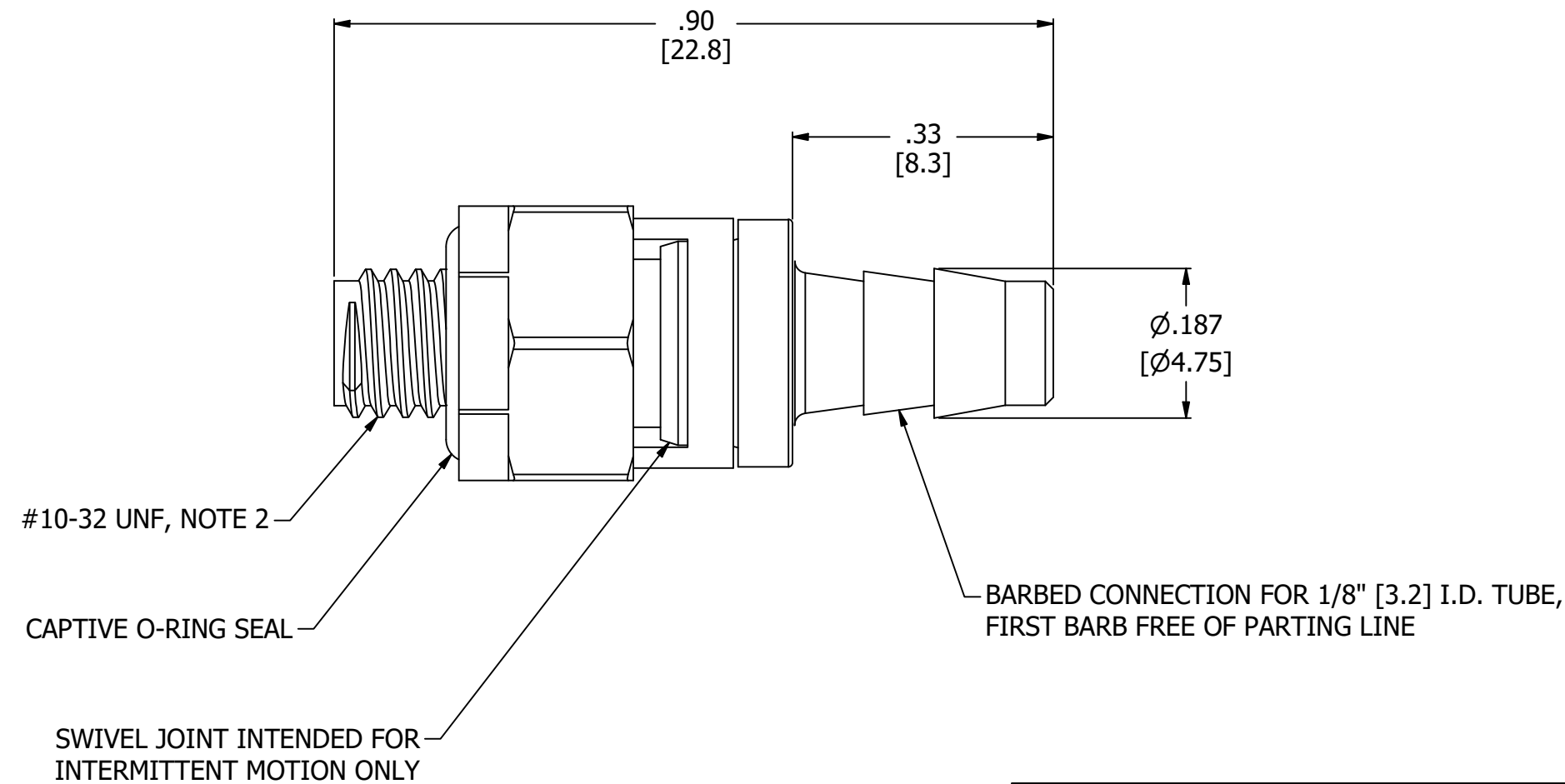
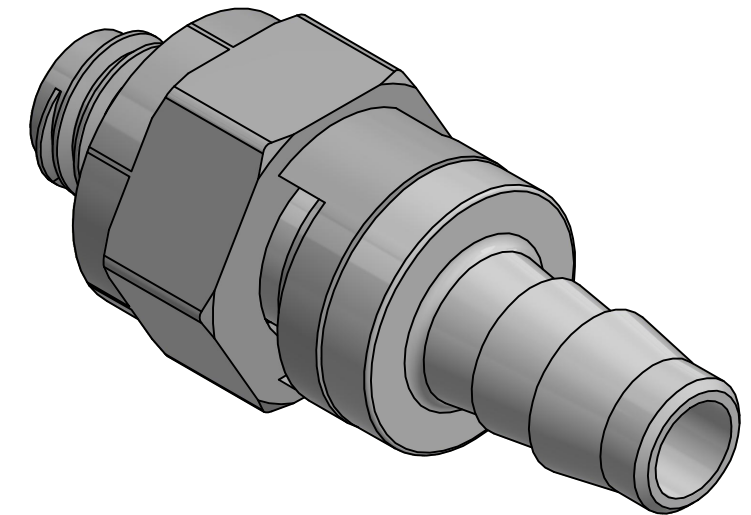

PRODUCT SPECIFICATIONS	
COLOR(S)	NATURAL POLYPROPYLENE
MEDIA	GASES, LIQUIDS
MAX INLET PRESSURE	125 PSI, [8.6 BAR]
TYPICAL TUBE RETENTION PRESSURE	125 PSI, [8.6 BAR], NOTE 3
MINIMUM INNER DIAMETER	$\varnothing.09$ [$\varnothing2.3$]
WETTED MATERIALS	POLYPROPYLENE, BUNA-N

 **AIR-LOGIC** @ DIVISION OF KNAPP MFG, INC.
 5102 DOUGLAS AVE RACINE, WI 53402
 PHONE: (262) 639-9035 FAX: (262) 639-5996 WEB: AIR-LOGIC.COM

PART/DRAWING NO.:

F215085PP

DESCRIPTION:
 POLYPROPYLENE STRAIGHT SWIVEL FITTING, #10-32 X 1/8"
 BARB, CAPTIVE O-RING SEAL

REVISION: A DRAWN: 3/9/2021
 SCALE: 5 : 1 SHEET SIZE: B

TERMS OF USE:
 THIS DRAWING IS FOR INFORMATIONAL PURPOSES ONLY. AIR LOGIC MAKES NO REPRESENTATIONS OF WARRANTIES CONCERNING SUITABILITY FOR ANY PARTICULAR PURPOSE. ALL PRODUCTS SUPPLIED ARE SUBJECT TO TERMS AND CONDITIONS FOUND AT AIR-LOGIC.COM

DRAWING TAKES PRECEDENCE OVER 3D MODEL GEOMETRY
 TOLERANCE: DECIMALS .00 ± .01, .000 ± .005, FRACTIONS ± 1/64
 ANGLES 1/4° UNLESS OTHERWISE SPECIFIED
 UNITS: INCHES [MILLIMETERS]